

# STC 2DSO500-2000 Series Anti-Hammering Slow Closing Pilot Solenoid Valves



## 2DSO500-2000 Series Solenoid Valve Specifications

Valve Model	2DSO400F	2DSO500F	2DSO650F	2DSO800F	2DSO1000F	2DSO1250F	2DSO1500F	2DSO2000F
Valve Type	2 Way, Normally Open (NO)							
Action	Pilot Diaphragm, Uni-Directional							
Orifice (mm)	40	50	65	80	100	125	150	200
Cv	21	30	52.5	81.7	128.4	221.7	291.7	513.5
Operating Pressure	6 to 120 PSI (AC Coil), 6 to 87 PSI (DC Coil)							
Operating Temperature	Media: -5 to 80°C (NBR Seal), -5 to 120°C (Viton Seal); Ambient: -5 to 45°C							
Port Size (Flange)	1 1/2"	2"	2 1/2"	3"	4"	5"	6"	8"
Body Materials	Stainless Steel							
Seal Materials	NBR (Buna N), Options: Viton, EPDM							
Coil Duty	Class H, IP65, 100% ED (Continuous Duty)							
Voltage	Voltage Options: 12, 24VDC; 24, 110/120, 220/240 VAC, 50/60Hz							
Voltage Tolerance	10% of Specified Voltage							
Coil Power	13W (100 PSI); 20W (175PSI)							
Electrical Connections	DIN 43650, Form A							
Installation	No Orientation Requirement (Optimum Position: Flow Horizontal and Solenoid Vertical)							
Service	Air, Inert Gas, Water, Liquid							

# 2DSO500-2000 SERIES SOLENOID VALVE COMPONENTS

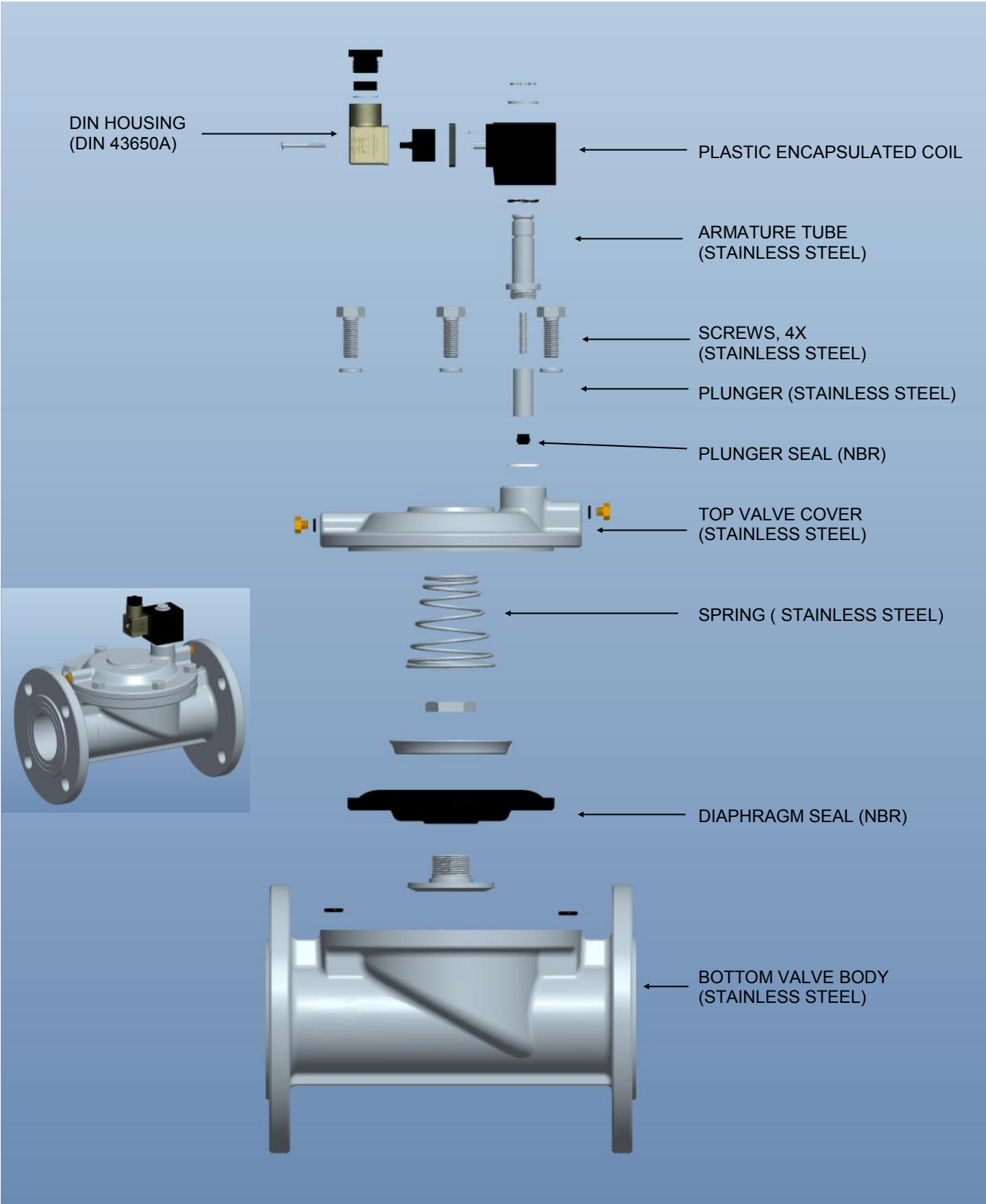

## Installation and Operation:

### To connect the valve Inlet and Outlet:

Connect the inlet and outlet in the direction of the arrow marked on the valve.

### To install coil:

Put the coil onto the armature tube of the valve. Put the lock-washer and nut onto the armature tube. Hand tighten the nut, then use a wrench to tighten the nut to a quarter turn; **do not over-tighten the nut, it may cause the armature tube to fail prematurely.**

### To connect DIN coil:

1. Remove the Philip screw from the plastic housing and unplug it from the DIN coil.
2. From the screw opening, push the terminal block out from the plastic housing.
3. Note the 1, 2 and ground markings on underside of DIN enclosure.
4. For DC DIN Coil, Connect 1 to Positive, 2 to Negative.
5. For AC DIN Coil, connect 1 to HOT wire, 2 to Neutral wire, and if required connect
6. **Do not energize the coil without installing it onto the valve, it will burn the coil and create fire hazards.**

**Safety Note:** Standard valves are supplied with continuous duty coils. The proper class of insulation for the service is indicated on the coil. The coil temperature may become hot after being energized for extended periods, but it is normal. Do not energize the coil without installing it onto the valve or connect the coil to a wrong voltage, as it may over-heat and damage the coil; although the coil is made of flame retarded material, misuse of the coil in this manner could create fire hazards and generate smoke or burning odor which indicates excessive coil temperature and should disconnect the power to the coil immediately.

### Operation: 2DSO series valve is a 2/2 Pilot Diaphragm, Normally Open Solenoid Valve.

**To close:** when the valve is energized, the coil repels the plunger. Then the plunger covers the main orifice. The system pressure builds up on the top of the diaphragm/piston through the bleed orifice, forcing the diaphragm/piston down until it covers the main orifice and stops media flow through the valve.

**To open:** when the valve is de-energized, the coil releases the plunger. The plunger uncovers the pilot orifice causing system pressure holding the diaphragm/piston closed to drop. As system pressure on the top of the diaphragm/piston is reduced, full system pressure on the opposite side of the diaphragm/piston acts to lift the diaphragm/piston away from the main orifice, which allows the full media flow through the valve.

The 2DSO series valve is to be used with clean media. If the pilot holes are block they need to be cleaned and unblock.

# STC Solenoid Coil Wiring Instructions

## ELECTRICAL CONNECTION PROCEDURE

### A: DIN Connector:

- [1] Remove the Philip screw from the plastic housing.
- [2] Unplug the plastic housing from the DIN coil.
- [3] From the screw opening, use the screw to push the terminal block out of the plastic housing.
- [4] Note the 1, 2, and ground markings on underside of DIN enclosure.
- [5] For DC DIN coil, connect 1 to positive, 2 to negative.
- [6] For AC DIN coil, connect 1 to HOT wire, 2 to neutral wire, and if required connect ground to ground wire.

### B: Grommet/Lead Wire Connector:

DC: Red=Positive, Black=Negative  
AC: Black=Hot, White=Neutral/Common

To download detail procedure: please visit [www.StcValve.com](http://www.StcValve.com)

StcValve.com; Tel:650-856 8833

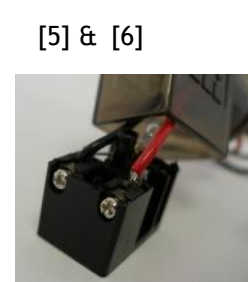
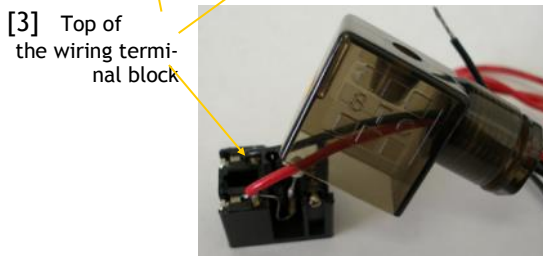
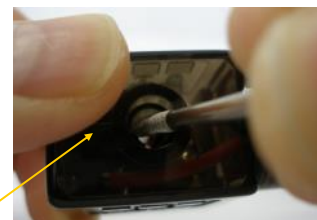

# 2DSO500-2000 Series Solenoid Valve Installation Dimensions

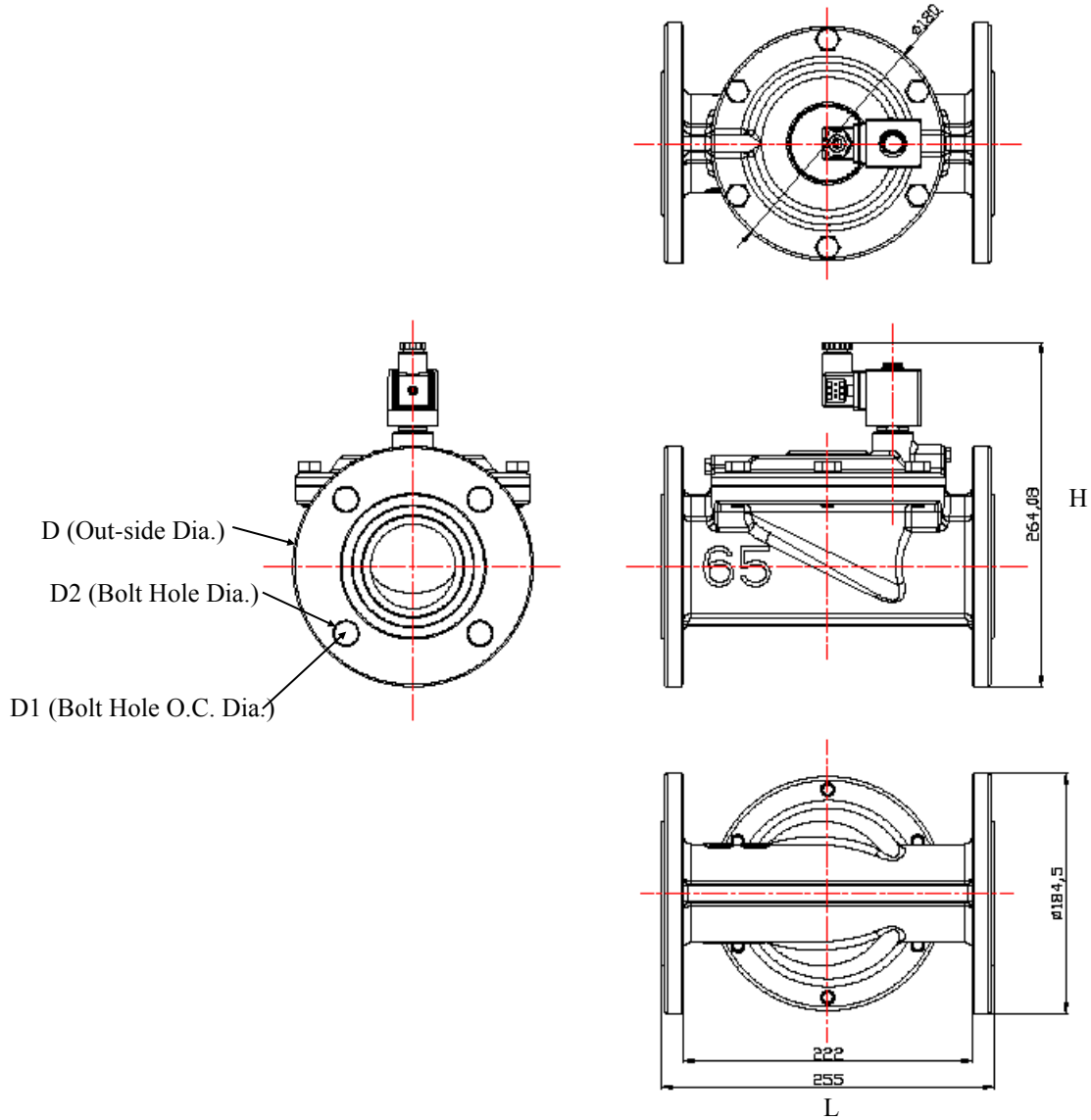

Model: 2DS Series Valves Dimensions (MM)									
Stainless Steel	Port Size	Orifice	Cv	D (OD)	D1 (OC)	D2 (Thread Hole Dia)	L	H	H1
2DS400F-1 1/2	1 1/2	40	21	150	110	18 (4x)	182	196	125
2DS500F-2	2	50	30	165	125	18 (4x)	215	200	120
2DS650F-2 1/2	2 1/2	65	52.5	185	145	18 (4x)	256	280	185
2DS800F-3	3	80	81.7	200	160	18 (8x)	277	287	190
2DS1000F-4	4	100	128.4	220	180	18 (8x)	350	330	230
2DS1250F-4	5	125	221.7	250	210	18 (8x)	425	437	310
2DS1500F-4	6	150	291.7	285	240	22 (8x)	450	460	318
2DS2000F-4	8	200	513.5	340	295	22 (12x)	560	547	380

## 2DS400-800 SERIES VALVE WATER FLOW RATE VS PRESSURE

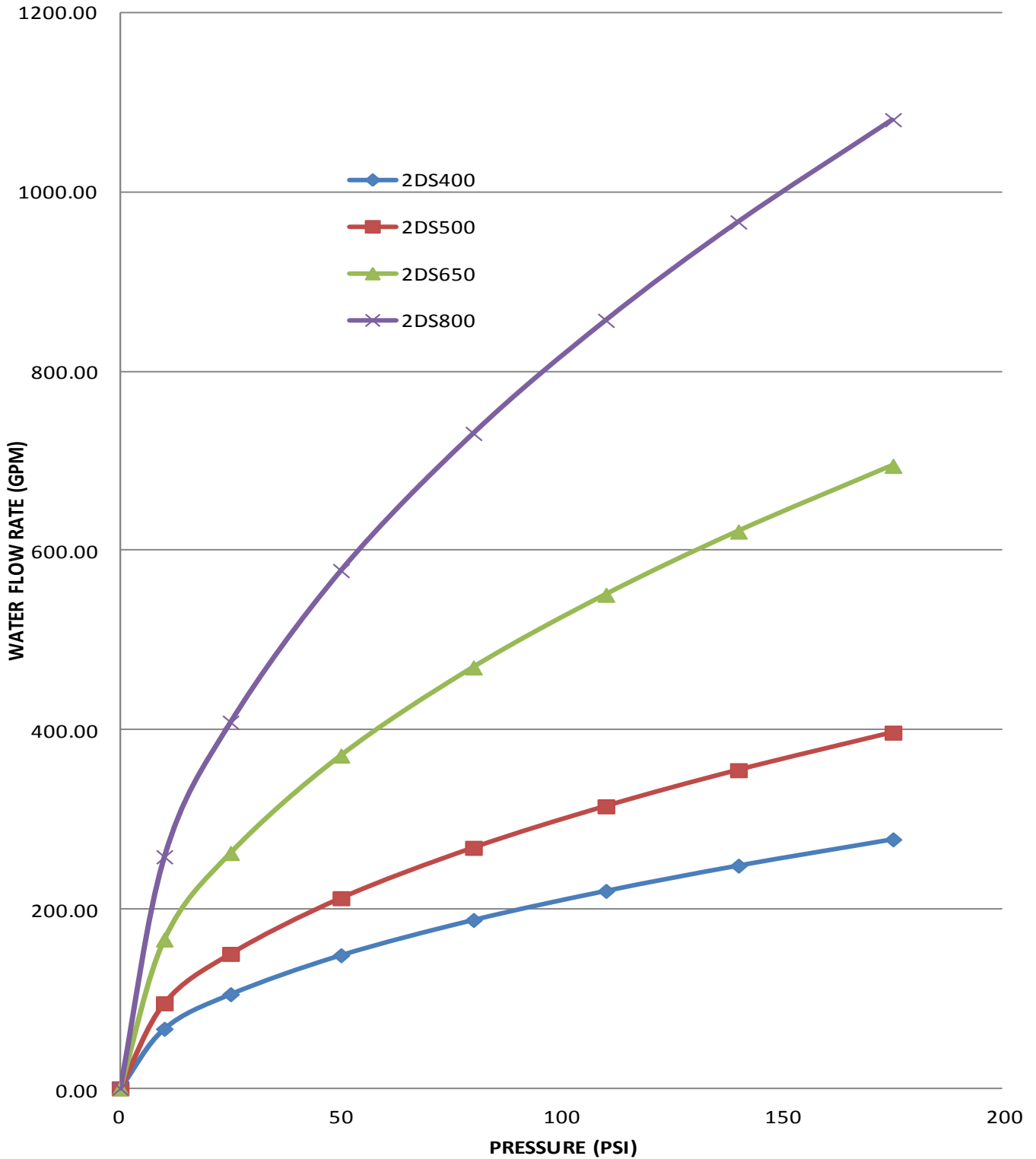

# 2DS1000-2000 SERIES VALVE WATER FLOW RATE VS PRESSURE

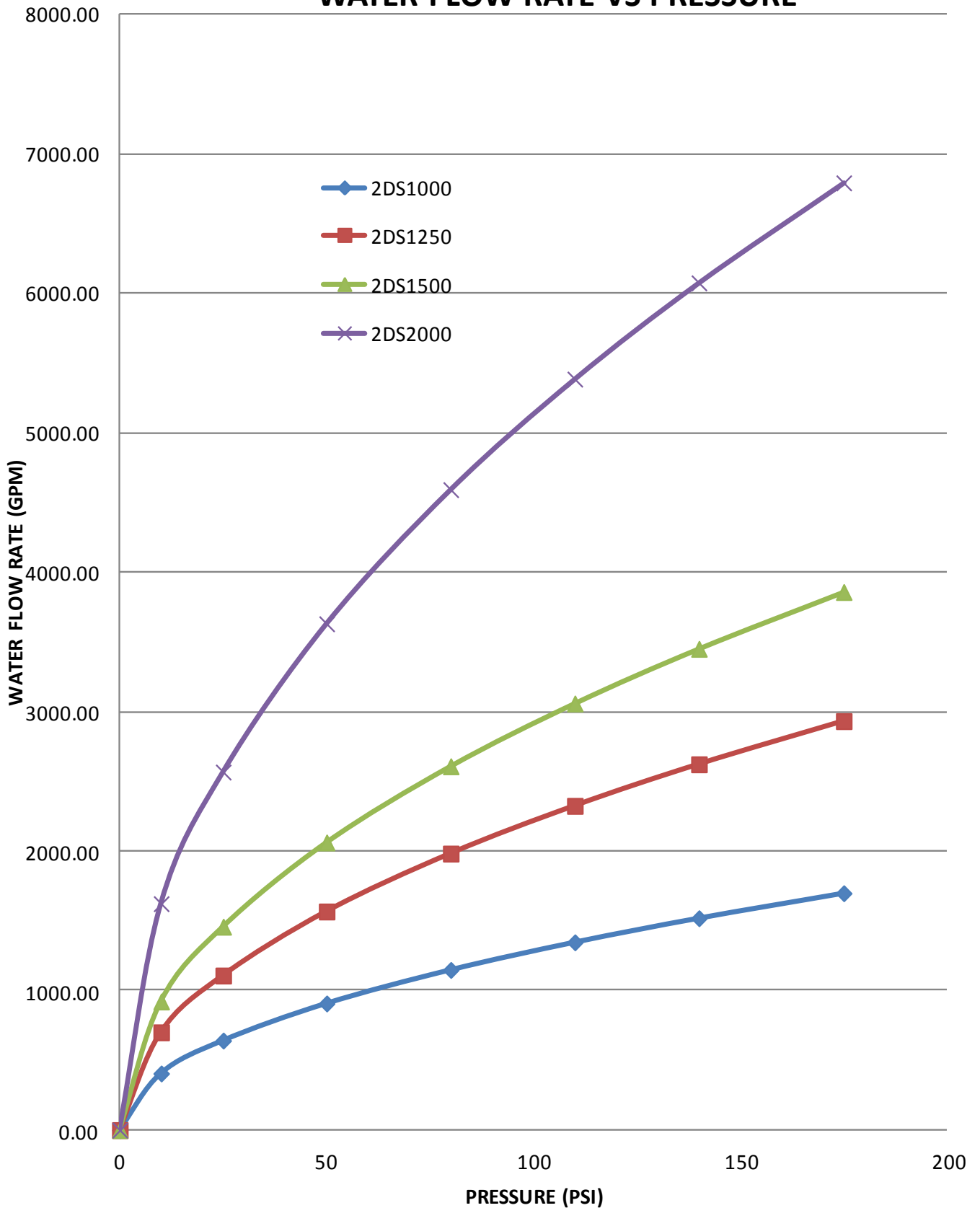

## Terms and Conditions

By purchasing from SIZTO TECH CORPORATION (STC), you agree to these TERMS AND CONDITIONS. No other terms shall apply except as agreed in writing signed by us. We reserve the right to correct typographic errors and reject orders.

### SHIPMENTS:

All shipments are F.O.B. 892 Commercial Street, Palo Alto, CA 94303, USA. Most orders are shipped via UPS Standard Ground unless instructions accompany order. Outside the UPS zones, shipment will be made Best Way. The responsibility for goods delay, lost or damaged in transit rests with the carrier and purchaser. Purchaser may purchase shipping insurance to cover lost or damaged products caused by shipping.

### RETURN OF MERCHANDISE:

No merchandise is accepted for return 30 days after delivery date. No credit allowed on merchandise shipped as ordered and returned without obtaining an authorization number IN ADVANCE. A 20% restocking charge applies to all returns, and transportation charges must be fully prepaid. We will pay **ground** transportation charges on re-sent or returned merchandise due to STC's error.

**Shortages & Mis-Shipments:** Any shortages or mis-shipment must be reported within 15 days.

### CANCELLATION POLICY:

Blanket order can be canceled 90 days before scheduled ship date. There will be a 10% charge if a blanket order is cancel within 90 days of scheduled ship date, and a 20% charge if cancel within 60 days. Regular order for non-custom parts can be canceled any time before the order is shipped. For custom parts, a 30% down payment is required either at the time of order or 90 days prior to scheduled ship date, whichever comes later.

### Remittances should be sent to:

Sizto Tech Corporation, 892 Commercial Street, Palo Alto, CA 94303, USA

Credit Card Payments: Visa, MasterCard, Discover, or American Express Accepted

**International Customers:** Advance Payment Required via Bank Wire, Cashier's Check or Approved Credit Card.

**Credit Application:** To establish a net 30 day account, please mail or fax three trade references with complete mailing addresses and account numbers.

### LIMITED WARRANTY – IMPORTANT NOTICE TO PURCHASER:

Sizto Tech Corporation (STC) only warrants this product to be free from defects in materials and workmanship at the time of shipment. This limited warranty expires one year after delivery to the end-user. STC's entire obligation to the Purchaser for breach of this limited warranty shall be limited to replacement of the defective product or refund of the original purchase price of this product, at STC's option. Purchaser has thirty (30) days to return the goods after STC has agreed to accept the return. All freight charges on returned material shall be paid by the Purchaser. STC's limited warranty shall not apply, however, to the product that have been subjected to misuse, alteration, accident or negligence during handling or storage.

### DISCLAIMER OF IMPLIED WARRANTIES:

All implied warranties, which may arise by implication of law or application of course of dealing or usage of trade, including, but not limited to, implied warranties of merchantability or fitness for a particular purpose are expressly excluded. There are no warranties, which extend beyond the description of the faced hereof. The end user is solely responsible for the suitability and fitness of this product selected for a particular application.

### OBLIGATIONS

You warrant, represent and agree: (1) to comply with all laws; (2) that our sale and shipment of the product will not, by export thereof, your legal status or otherwise, cause us to violate any law; and (3) to indemnify us against any losses from a failure by you or a third party to comply with law or these terms and conditions, or from use of the product.

### SAFETY WARNING

**Failure or improper selection or improper use of the components and products described herein or related items can cause death, personal injury and/or property damage.** This document and other related information from STC provide products options for further investigation by users having the technical expertise. It is important that you analyze all aspects of your application and review the information concerning the component or product in the current catalog. Due to the variety of operation conditions and applications for these components or products, the user, through his own analysis and testing, is solely responsible for making the final selection, installation and maintenance of the products and assuring that all performance, safety and warning requirements of the application are met. All products set-ups and maintenance require the supervision of a qualified individual who is familiar with installation, inspection and testing through training or experience.

### IMPORTANT NOTICE:

The products described herein, including without limitation, product features, specifications, design, availability and pricing, are subject to change without notice. We continuously improve the products, and we reserve the right to change specifications without incurring any obligation to incorporate new factors in equipment previously sold.



**Sizto Tech Corporation**

892 Commercial Street  
Palo Alto, CA 94303 USA

Tel: 650-856 8833 | Fax: 650-856 8811

Email: [Sales@StcValve.com](mailto:Sales@StcValve.com); [www.StcValve.com](http://www.StcValve.com)